

10 9 8 7 6 5 4 3 2 1

F  
E  
D  
C  
B  
A

F  
E  
D  
C  
B  
A

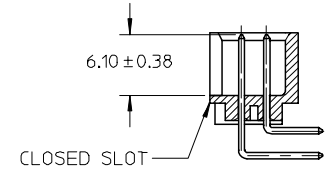
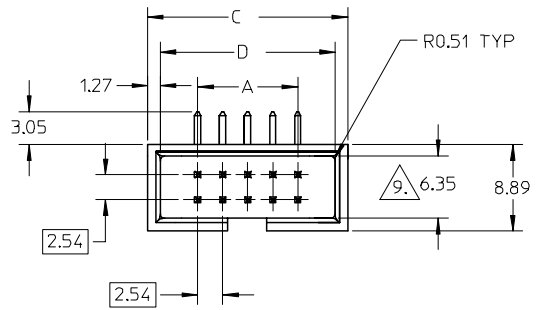

MOLEX IRELAND PRODUCTION ONLY  
(OPTION)

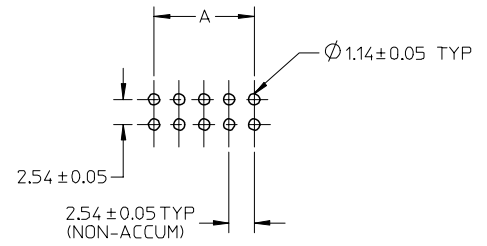

RECOMMENDED PCB HOLE LAYOUT

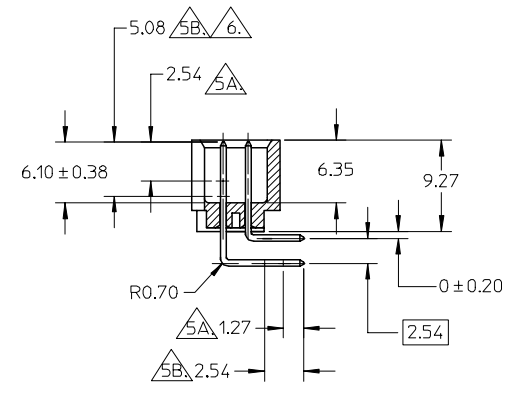
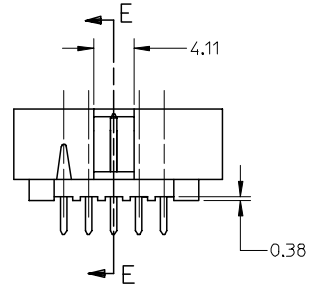

SECTION E-E

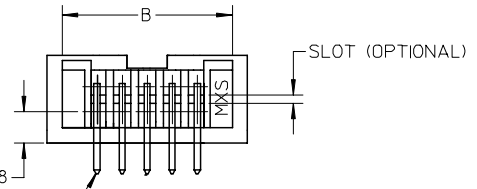
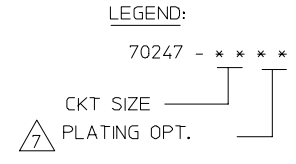

AT TIPS BOTH ENDS  
Ø 0.38

REVISED NOTES 7 EC NO: S2007-0009 DRWN:GMENARLY 2006/07/26 CHKD:MLONG 2006/07/26 APPR:SKTOH 2006/07/27	DESCRIPTION H1	QUALITY SYMBOLS	GENERAL TOLERANCES (UNLESS SPECIFIED)	DIMENSION STYLE MM ONLY	SCALE NTS	DESIGN UNITS METRIC	THIRD ANGLE PROJECTION	
		▽=0 ▽C=0	4 PLACES ± --- ± --- 3 PLACES ± --- ± --- 2 PLACES ± 0.20 ± --- 1 PLACE ± --- ± --- ANGULAR ± 3 °	DRAWN BY JENNIFER DATE 1987/09/21 CHECKED BY MLAI DATE 1987/09/21 APPROVED BY ALANB DATE 1987/09/21	TITLE	C-GRID, SHROUDED HEADER R/A (SLOTTED W/O STANDOFFS)		
		DRAFT WHERE APPLICABLE MUST REMAIN WITHIN DIMENSIONS	SEE TABLE	MOLEX INCORPORATED		SHEET NO. 1 OF 2		
		SIZE A3	THIS DRAWING CONTAINS INFORMATION THAT IS PROPRIETARY TO MOLEX INCORPORATED AND SHOULD NOT BE USED WITHOUT WRITTEN PERMISSION		DOCUMENT NO. SDA-70247-* * 00-04			

9 8 7 6 5 4 3 2 1

10 9 8 7 6 5 4 3 2 1

**NOTES:**

1. PIN PUSHOUT FORCE (.9072KG)/2LBS MIN.
2. PIN SOLDERABILITY PER MOLEX SPEC. ES-152.
3. PRODUCT SPEC: PS-70246 APPLIES.
4. WAFER TO BE FLAT WITHIN .003 MM/MM.
5. DIMENSIONS FOR PLATING LOCATION:

 MEASURE POINT FOR THICKNESS

 MINIMUM COVERAGE

 GOLD END OF PIN UNLESS OVERALL PLATED.

 FINISH: - 51 : 15 MICRO INCHES MIN GOLD PLATE ON CONTACT AND 75 MICRO INCHES MIN TIN PLATE ON SOLDERTAIL BOTH OVER 50 MICRO INCHES MIN NICKEL OVERALL.

- 52 : 30 MICRO INCHES MIN GOLD PLATE ON CONTACT AND 75 MICRO INCHES MIN TIN PLATE ON SOLDERTAIL BOTH OVER 50 MICRO INCHES MIN NICKEL OVERALL.

- 54 : 5 MICRO INCHES MIN GOLD PLATE ON CONTACT AND 75 MICRO INCHES MIN TIN PLATE ON SOLDERTAIL BOTH OVER 50 MICRO INCHES MIN NICKEL OVERALL.

 CHECK WITH SALES OFFICE FOR AVAILABILITY.



 DIM AT THE CENTRE OF THE SHROUDED WALL SHALL BE 5.91MM MIN. THIS SPEC IS VALID FOR ALL CKT SIZE.

10. MATERIAL:

HSG: PBT, GLASS FILLED, UL94V-0, COLOUR: BLACK (SPEC NO: 89992-0028)

PIN: 0.64MM SQ. PIN PHOSPHOR BRONZE.

PART NUMBER 	CKT SIZE	DIM A	DIM B	DIM C	DIM D
70247-08**	08	7.62	14.73	17.78	15.24
70247-10**	10	10.16	17.27	20.32	17.78
70247-12**	12	12.70	19.81	22.86	20.32
70247-14**	14	15.24	22.35	25.40	22.86
70247-16**	16	17.78	24.89	27.94	25.40
70247-20**	20	22.86	29.97	33.02	30.48
70247-24**	24	27.94	35.05	38.10	35.56
70247-26**	26	30.48	37.59	40.64	38.10
70247-30**	30	35.56	42.67	45.72	43.18
70247-34**	34	40.64	47.75	50.80	48.26
70247-40**	40	48.26	55.37	58.42	55.88
70247-44**	44	53.34	60.45	63.50	60.96
70247-48**	48	58.42	65.53	68.58	66.04
70247-50**	50	60.96	68.07	71.12	68.58
70247-56**	56	68.58	75.69	78.74	76.20
70247-60**	60	73.66	80.77	83.82	81.28
70247-64**	64	78.74	85.85	88.90	86.36
70247-72**	72	88.90	96.01	99.06	96.52

REVISED NOTES 7 EC NO: S2007-0009 2006/07/26 DRWN:GMENARLY 2006/07/26 CHKD:MLONG 2006/07/26 APPR:SKTOH 2006/07/27	QUALITY SYMBOLS  = 0  = 0	GENERAL TOLERANCES (UNLESS SPECIFIED)		DIMENSION STYLE MM ONLY		SCALE NTS	DESIGN UNITS METRIC	THIRD ANGLE PROJECTION		
			mm	INCH	DRAWN BY JENNIFER	DATE 1987/09/21	TITLE C-GRID, SHROUDED HEADER R/A (SLOTTED W/O STANDOFFS)			
		4 PLACES	± ---	± ---	CHECKED BY MLA1	DATE 1987/09/21				
		3 PLACES	± ---	± ---	APPROVED BY ALANB		DATE 1987/09/21	MATERIAL NO. SDA-70247-*00-04		
2 PLACES	± 0.20	± ---	DRAFT WHERE APPLICABLE MUST REMAIN WITHIN DIMENSIONS		SIZE A3	DOCUMENT NO. SDA-70247-*00-04	SHEET NO. 2 OF 2			
1 PLACE	± ---	± ---	THIS DRAWING CONTAINS INFORMATION THAT IS PROPRIETARY TO MOLEX INCORPORATED AND SHOULD NOT BE USED WITHOUT WRITTEN PERMISSION							

9 8 7 6 5 4 3 2 1